

PQ2Lxxx2MSPQ Series

2-Output Type
Low Power-Loss Voltage Regulators

■ Features

- 1.Compact surface mount package (4.5x4.3x1.5mm)
- 2.Each channel 250mA
Output 1:Voltage 3.3V / 2.5V
Output 2:Voltage 3.3V / 2.5V / 1.8V / 1.5V
- 3.Power dissipation : MAX.900mW
(At surface-mounted condition)
- 4.Low power-loss
(Dropout voltage : MAX. 0.4V at $I_o=100mA$)
- 5.Use of ceramic capacitor is possible as output smooth capacitor
- 6.RoHS directive compliant

■ Applications

- 1.CD-ROM drives
- 2.DVD-ROM drives
- 3.Digital Still Cameras

■ Absolute Maximum Ratings

($T_a=25^\circ C$)

| Parameter | Symbol | Rating | Unit |
|-------------------------|-----------|-------------|------------|
| *1 Input voltage | V_{IN} | 9 | V |
| Output current | I_{o1} | 250 | mA |
| | I_{o2} | 250 | |
| *2 Power dissipation | P_D | 900 | mW |
| *3 Junction temperature | T_j | 150 | $^\circ C$ |
| Operating temperature | T_{opr} | -30 to +80 | $^\circ C$ |
| Storage temperature | T_{stg} | -55 to +150 | $^\circ C$ |
| Soldering temperature | T_{sol} | 270(10s) | $^\circ C$ |

*1 All are open except GND and applicable terminals.
*2 At surface-mounted condition
*3 Overheat protection may operate at $T_j:125^\circ C$ to $150^\circ C$

■ Outline Dimensions

(Unit : mm)

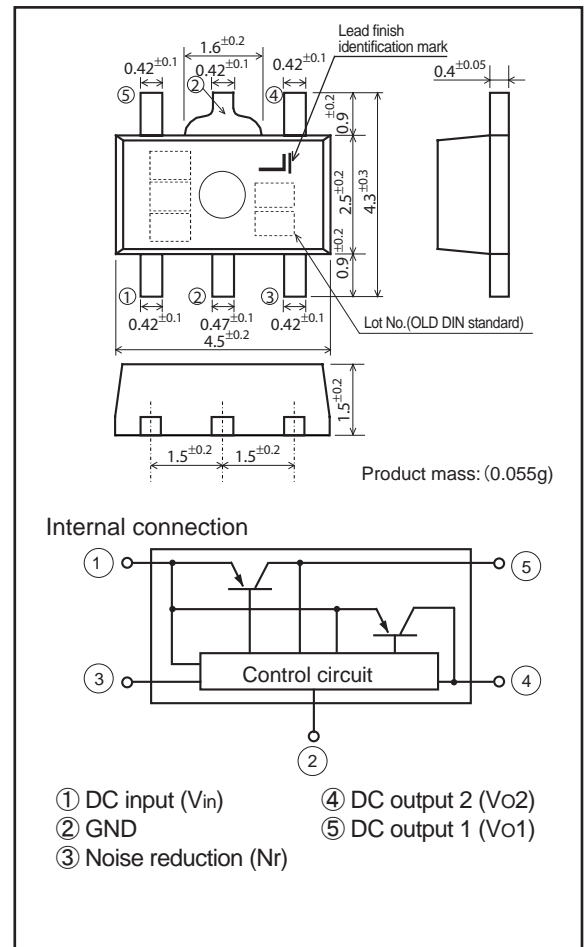

Product mass: (0.055g)

Lead finish:Lead-free solder plating
(Composition: Sn2Bi)

Notice The content of data sheet is subject to change without prior notice.

In the absence of confirmation by device specification sheets, SHARP takes no responsibility for any defects that may occur in equipment using any SHARP devices shown in catalogs, data books, etc. Contact SHARP in order to obtain the latest device specification sheets before using any SHARP device.

Electrical Characteristics

(Unless otherwise specified condition shall be $V_{in}=V_{o1}(TYP.)+1.0V$, $I_{o1}=0mA$, $I_{o2}=0mA$, $T_a=25^{\circ}C$)

| Parameter | Symbol | Conditions | MIN. | TYP. | MAX. | Unit |
|---|---------------|---|-----------------|------|------|-----------------|
| Output voltage | V_o | - | Refer to list.1 | | | V |
| Load regulation | RegL1 | $I_{o1}=5$ to 200mA | - | 30 | 160 | mV |
| | RegL2 | $I_{o2}=5$ to 200mA | - | 30 | 160 | |
| Line regulation | RegL1 | $V_{in}=V_{o1}(TYP.)+1V$ to $V_{o1}(TYP.)+6V(MAX.9V)$, $I_{o1}=30mA$ | - | 3 | 20 | mV |
| | RegL2 | $V_{in}=V_{o2}(TYP.)+1V$ to $V_{o2}(TYP.)+6V(MAX.9V)$, $I_{o2}=30mA$ | - | 3 | 20 | |
| Temperature coefficient of output voltage | TcVo1 | $I_{o1}=10mA$, $T_j=-25$ to $75^{\circ}C$ | - | 0.1 | - | mV/ $^{\circ}C$ |
| | TcVo2 | $I_{o2}=10mA$, $T_j=-25$ to $75^{\circ}C$ | - | 0.1 | - | |
| *4 Ripple rejection | RR | Refer to Fig.2 | - | 60 | - | dB |
| Output noise voltage | $V_{no(rms)}$ | $10Hz < f < 100kHz$, $I_o=30mA$, $C_n=0.01\mu F$ | - | 50 | - | μV |
| Dropout voltage | V_{I-o1} | $I_{o1}=100mA$, *5 | - | 0.16 | 0.4 | V |
| | V_{I-o2} | $I_{o2}=200mA$, *5 | - | 0.24 | 1.0 | |
| Quiescent current | I_q | - | - | 250 | 400 | μA |

*4 Typical value of 3.3V output model.

*5 Input voltage when output voltage falls 0.1V from that at $V_{in}=V_o(TYP.)+1.0V$.
However, $V_{in} \geq 2.3V$.

List.1 Output voltage

($V_{in}=V_{o1}(TYP.)+1.0V$, $T_a=25^{\circ}C$)

| Parameter | Model No. | Symbol | Conditions | MIN. | TYP. | MAX. | Unit |
|----------------|--------------|----------|------------------------------|-------|------|-------|------|
| Output voltage | PQ2L3332MSPQ | V_{o1} | $I_{o1}=30mA$, $I_{o2}=0mA$ | 3.234 | 3.3 | 3.366 | V |
| | | V_{o2} | $I_{o1}=0mA$, $I_{o2}=30mA$ | 3.234 | 3.3 | 3.366 | |
| | PQ2L3252MSPQ | V_{o1} | $I_{o1}=30mA$, $I_{o2}=0mA$ | 3.234 | 3.3 | 3.366 | |
| | | V_{o2} | $I_{o1}=0mA$, $I_{o2}=30mA$ | 2.440 | 2.5 | 2.560 | |
| | PQ2L3182MSPQ | V_{o1} | $I_{o1}=30mA$, $I_{o2}=0mA$ | 3.234 | 3.3 | 3.366 | |
| | | V_{o2} | $I_{o1}=0mA$, $I_{o2}=30mA$ | 1.740 | 1.8 | 1.860 | |
| | PQ2L3152MSPQ | V_{o1} | $I_{o1}=30mA$, $I_{o2}=0mA$ | 3.234 | 3.3 | 3.366 | |
| | | V_{o2} | $I_{o1}=0mA$, $I_{o2}=30mA$ | 1.440 | 1.5 | 1.560 | |
| | PQ2L2182MSPQ | V_{o1} | $I_{o1}=30mA$, $I_{o2}=0mA$ | 2.440 | 2.5 | 2.560 | |
| | | V_{o2} | $I_{o1}=0mA$, $I_{o2}=30mA$ | 1.740 | 1.8 | 1.860 | |
| | PQ2L2152MSPQ | V_{o1} | $I_{o1}=30mA$, $I_{o2}=0mA$ | 2.440 | 2.5 | 2.560 | |
| | | V_{o2} | $I_{o1}=0mA$, $I_{o2}=30mA$ | 1.440 | 1.5 | 1.560 | |

Fig.1 Standard measuring circuit of Regulator portion

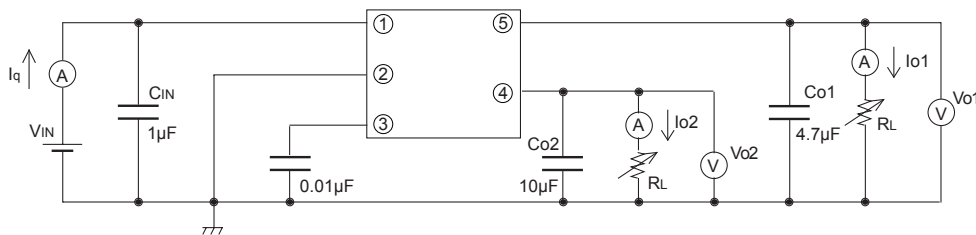

Fig.2 Standard measuring circuit of critical rate of ripple rejection

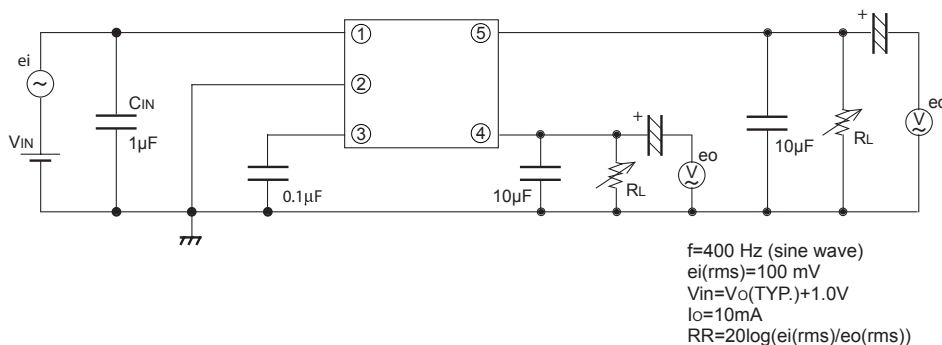
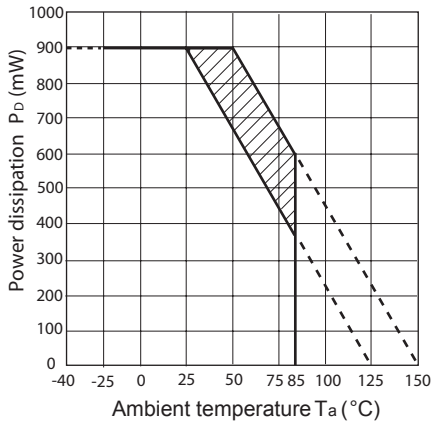
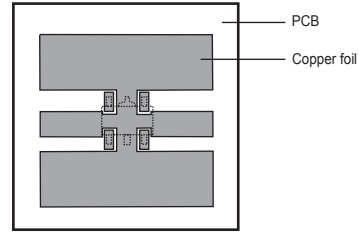

Fig.3 Power Dissipation vs. Ambient Temperature



Note) Oblique line portion: Overheat protection may operate in this area.

Mounting PCB



Material : Glass-cloth epoxy resin
 PCB Size : 20×20×1.0mm
 Copper foil area : 180mm²
 Thickness of copper : 35μm

Fig.4 Overcurrent Protection Characteristics (Typical Value)

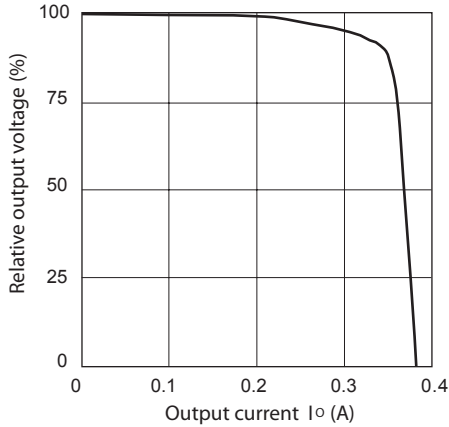

Fig.5 Reference Voltage Deviation vs. Junction Temperature (PQ2L3252MSPQ)(Typical Value)

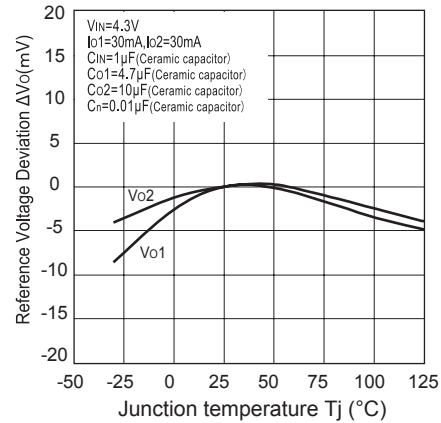

Fig.6 Output Voltage(Vo1) vs. Input Voltage (PQ2L3152MSPQ)(Typical Value)

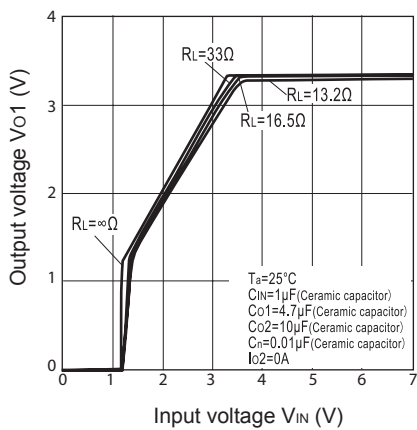

Fig.7 Output Voltage(Vo2) vs. Input Voltage (PQ2L3152MSPQ)(Typical Value)

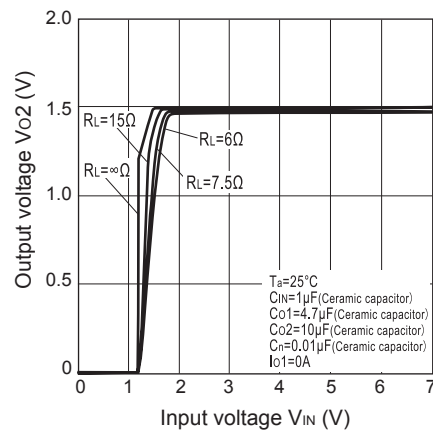

Fig.8 Circuit Operating Current vs. Input Voltage (PQ2L3152MSPQ)(Typical Value)

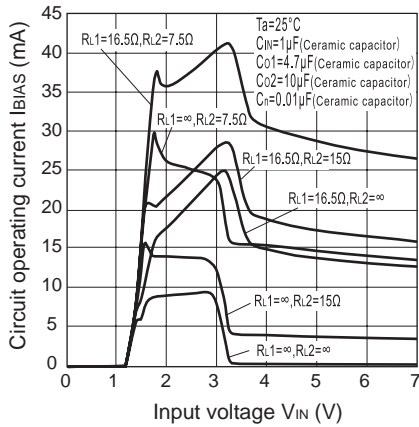

Fig.9 Dropout Voltage vs. Junction Temperature (PQ2L3252MSPQ)(Typical Value)

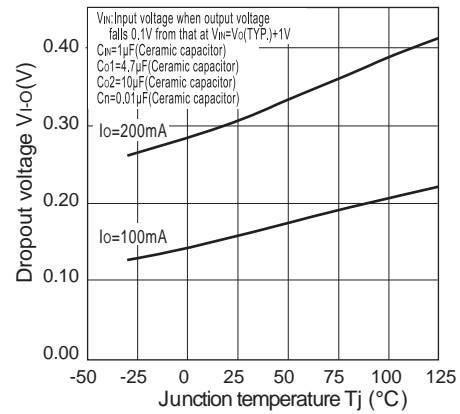

Fig.10 Quiescent Current vs. Junction Temperature (PQ2L3252MSPQ)(Typical Value)

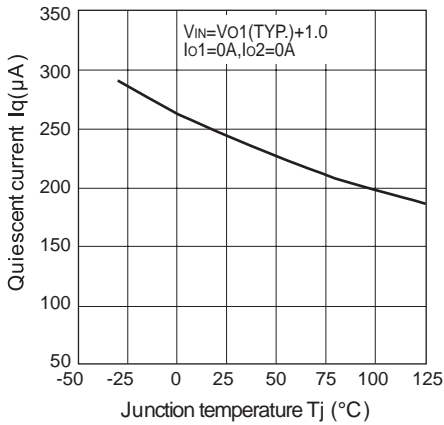

Fig.11 Ripple Rejection vs. Input Ripple Frequency (PQ2L3182MSPQ)(Typical Value)

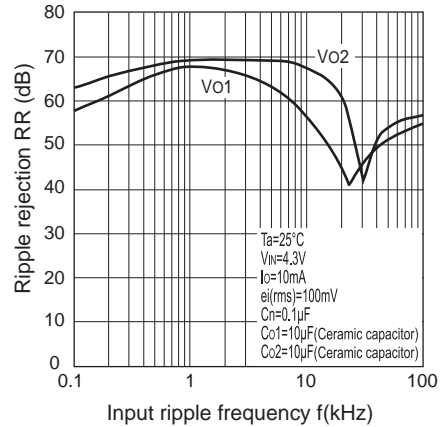

Fig.12 Dropout Voltage vs. Output Current (Typical Value)

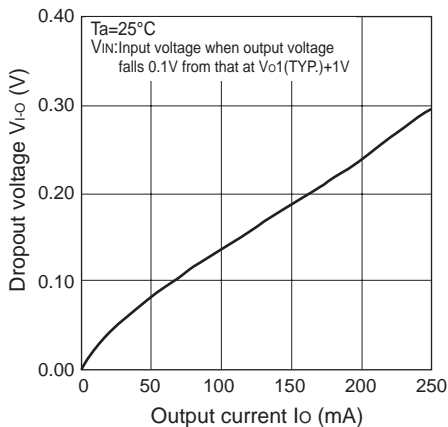

Fig.13 Output Peak Current vs. Junction Temperature (Typical Value)

